

WATERCO POOL HEAT PUMP

Electr Heat MKV

Electr Heat Plus

Electr Heat
ECO-V

Electr Heat
ULTRA

AQUA
FLOW

GEYSER 50

Installation and Operation Manual



WARNING

This equipment must be installed and serviced by a qualified technician. Improper installation can create electrical hazards which could result in property damage, serious injury or death. Improper installation will void the warranty.



Notice to Installer

This manual contains important information about the installation, operation and safe use of this product. Once the product has been installed this manual must be given to the owner/operator of this equipment.

Table of Contents

IMPORTANT SAFETY INSTRUCTIONS	02
A NOTE TO YOU	03
INSTALLATION INSTRUCTIONS	05
Location	05
Installation Clearances	06
Water Piping	07
Water Flow Rate	07
Water By-pass Kit	07
Plumbing Diagram	08
Electrical	09
Electrical Connection	09
Breaker Size	09
Electrical Wire Size	09
Bonding	10
Bonding Diagram	10
Quick Connector	11
Connection Overview	11
Wiring Diagram	12
Setting Up Quick Connector For Heat Pump -- (9kW -15kW)	12
Quick Connector For Heat Pump (25kW -44kW)	13 & 15
Water Pump Control (First time set-up)	13
Pump Control Sequence	14
Usage Of Chemical Products	15
Performance Specifications	16
WIFI SET UP INSTRUCTIONS	17
Install the Waterco Connect app	17
Pair your Electroheat to your app	18
Troubleshooting	20
OPERATION OF YOUR POOL HEAT PUMP	21
CONTROLLER TYPES	
Initial Heating	21
Adjustment Of The Bypass Valves	21
Pool Heat Pump Running Time	22
Pool Solar Blanket	22
Defrost Cycle	22
To Start The Pool Heat Pump	23
To Stop The Pool Heat Pump	23
To Check and Adjust Temperature Settings	24
Temperature Calibration	25
To Change Display From Fahrenheit To Celsius	26
Defrost for Electroheat Ultra	26
Protection Devices	26
Codes	26

INVERTER POOL HEAT PUMP CONTROLLER	27
Inverter Controller Operation	28
Timer Function	28
Function Descriptions	29
Buzzer	29
Memory Function	29

MAINTENANCE OF YOUR POOL HEAT PUMP	30
Cabinet Cleaning	30
Cleaning Evaporator	30
Cleaning drainage holes	30
Units Located In Coastal Locations	30
Winterising Procedure	31

GENERAL SAFETY INSTRUCTIONS	32
------------------------------------	----

TROUBLESHOOTING	33
Nothing Is Working and The Electronic Control Does Not Operate	33
Nothing Is Working But The Electronic Control Temperature Displays Digits or a Code	33
Fan Doesn't Work (The Fan Blades Are Not Moving)	33
Fan Blades Turn, But Compressor Is Not Functioning	34
Compressor Starts and Stops	34
There Is Water Around The Pool Heat Pump	34
Pool Heat Pump Has Ice Formed On The Evaporator Coil	35
Pool Heat Pump Is Functioning, But Does Not Reach The Desired Temperature Setting	35
Analysis Chart	36
Circuit Breaker Trips	36
The Pool Heat Pump Is Noisy	37
The Temperature Shown On Pool Heat Pump Is Not The Same That Is Shown By The Pool Thermometer	37
Service Analyser Codes	38

WARRANTY	42
-----------------	----

IMPORTANT SAFETY INSTRUCTIONS

When using this electrical equipment, basic safety precautions should always be followed, including the following:

READ AND FOLLOW ALL INSTRUCTIONS

! WARNING: Disconnect all AC power during installation and servicing.

! WARNING: In order to avoid the possibility of hyperthermia (heat stress) occurring it is recommended the average temperature of the spa - pool water does not exceed 40°C.

! WARNING: The pool heat pump is not intended for use by persons (including children) with reduced physical sensory or mental capabilities, or lack of experience and knowledge, unless they have been provided supervision or instruction concerning use of the appliance by a person responsible for their safety. Children should be supervised to ensure they do not play with the appliance.

- In certain situations unexpected start up may occur when the appliance is in automatic mode.
- The installer should assess the risk associated with unexpected start-up of this device which, in any circumstance should have no hazardous effect.
- The pool heat pump is not meant to provide safety protection for other devices.
- The pool heat pump should be deactivated if the pool or spa has been drained.
- Waterco pool heat pumps must be installed by a suitably qualified person in accordance with current Regulatory Standards, the applicable Wiring Rules (AS3000) and local statutory authority regulations.
- Parts containing live parts, except parts supplied with safety extra-low voltage not exceeding 12V, must be inaccessible to a person in the spa - pool.
- Parts incorporating electrical components, except remote control devices, must be located or fixed so that they cannot fall into the spa - pool.
- The appliance should be supplied through a residual current device (RCD) having a rated residual operating current not exceeding 30mA.
- An Earth terminal is located inside the wiring enclosure. To reduce the risk of electric shock, this terminal must be connected to the grounding means provided in the electric supply service panel with a continuous copper wire as sized to comply with current Standards and local statutory authorities in relation to the circuit conductors supplying the equipment.
- A cable connector is provided on this unit to connect a suitably sized copper conductor between this unit and any metal equipment, metal enclosures of electrical equipment, metal water pipe, or conduit within 1.5m of the unit via equipotential bonding.

SAVE THESE INSTRUCTIONS.

A NOTE TO YOU

Congratulations!

Thank you for choosing a Waterco pool heat pump to heat your pool.

Using the latest technology in heat capture, the Waterco pool heat pump converts the energy released by the sun and transfers it efficiently to your swimming pool.

During certain periods it may be necessary to operate your pool heat pump continuously during the day in cooler periods however, this should not be of concern as your Waterco pool heat pump can heat up your pool 80% more economically than the fossil fuel heating or heaters with electric elements. Waterco pool heat pumps are designed specifically to heat up your swimming pool economically.

To appreciate the benefits that the product will bring you, make sure to operate the unit when the atmospheric conditions specified in this document are present in addition of using a solar blanket to minimize heat loss which will influence operating costs and size of the unit required. Pools not covered with a solar blanket lose 2 to 3 times more heat, regardless of types of heating!

This manual applies to the following models:

All fixed speed units

Electroheat ECO-V 12kW TV Inverter heat / cool with automatic de-icing (single phase)

Record your model's information.

Keep this manual and your original proof of purchase receipt for warranty and future reference.

On the base of your pool heat pump is a name plate which contains information such as model number, serial number and electrical information.

Please write these down below and have them handy incase of a service call request.

Model Number _____

Serial Number _____

Purchase Date _____

Dealer Name _____

Dealer Address _____

Dealer Phone _____

To find detailed product information, the location of the nearest dealer or to register your pool heat pump please visit our website www.waterco.com and select your location.

INSTALLATION INSTRUCTIONS

Location

To gain maximum efficiency for your pool heat pump please follow all instructions when “positioning the unit”. It is also important to allow clearances for future service and maintenance procedures.

The unit is designed for outdoor installation and should not be installed in a totally enclosed area such as a shed, garage, etc., unless assisted ventilation of the cold exhaust air is provided to ensure adequate air exchange for correct operation. Re-circulation of cold discharged air back into the evaporator coil should be avoided and will greatly reduce unit’s heating capacity and efficiency.

The unit should be located as close as practically possible to the existing pool pump and filter to minimize water piping. The use of 90 degree bends and short radius elbows in the water piping should be kept to a minimum.

Mount the unit on a sturdy base, preferably a concrete slab or blocks. The base should be completely isolated from the building foundation or wall to prevent the possibility of sound or vibration transmission into the building. The size of the base should not be less than the base of the pool heat pump.

Use of anti vibration mat between the base of the unit and final installation location material is highly recommended to reduce potential vibration noise issues.

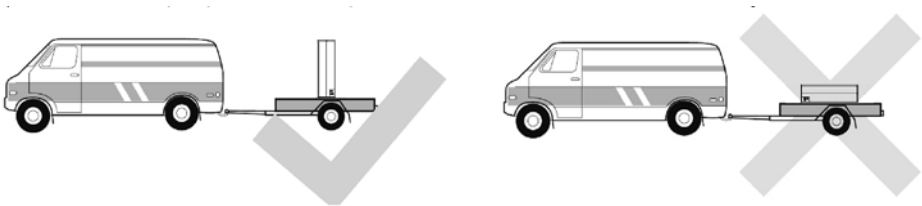

Installation Clearances

Air is pulled through the evaporator coil and discharged through the top or front grill. Clearances must be allowed in front and around the unit for unrestricted air discharge and service access. See Figure 1 and Figure 2. Failure to comply to the set clearances may cause diminished unit performance and reduced unit longevity.

Top Discharge Models

No obstruction above to allow cold air dispersal



Figure 1

Side Discharge Models

Clearance to rear minimum 30cm

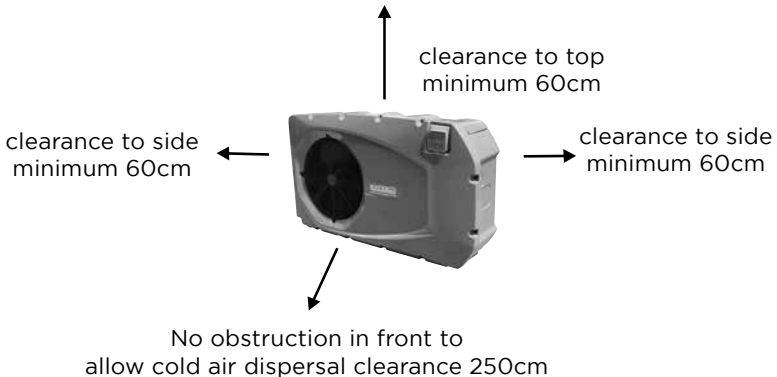

Figure 2

Water Piping

The below plumbing layout must be followed without exception:

1. pool pump
2. filter
3. pool heat pump
4. chlorinator (when installed).

Rigid PVC piping is recommended with all joints primed and glued with a suitable PVC adhesive cement. If rigid PVC pipe is not available, a suitable flexible hose of adequate diameter may be utilised with stainless steel clamps. When the piping installation is complete, operate the pool pump and check the system for leaks. Then check the filter pressure gauge to see that excessive pump head pressure is not indicated.

Water Flow Rate

The recommended water flow rate to ensure maximum heat transfer efficiency is between 120 - 300 litres per minute. The optimal flow rate is the mid point of this range. Use the bypass valve to adjust the flow rate to within the recommended range.

The optimum water in / water out temperature differential is 2-3°C.

Waterco recommend FlowVis for precise flow measurement and tuning.

Water By-pass Kit

A bypass kit consisting of three X two way valves must be installed for adjustment of water flow and ease of service. Waterco offer prefabricated water bypass kits to fit their heat pump domestic range. Ask your local Waterco sales office for details.

Plumbing Diagram

VITAL

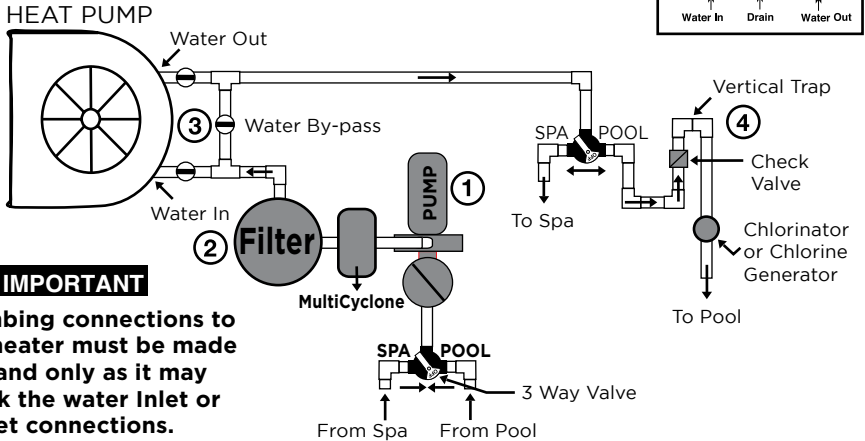

IMPORTANT

Plumbing connections to the heater must be made by hand only as it may break the water Inlet or Outlet connections.

1. A check valve or a loop MUST be installed between the pool heat pump and any automatic chlorinator to prevent highly chlorine concentrated water from flowing back to the pool heat pump when the pool pump is not running.
2. These units are fitted with a flow switch which are not effected by water pressure. Therefore, the fitment of a flow check valve due to the installed height either above or below water level is not required.
3. For units installed above the pool water level the return water to the pool valve on the bypass valve set should be closed approximately 15 - 20% to ensure the heat exchanger is completely full of water to allow the heat transfer to occur.
4. Ensure the heat exchanger canister is always full of water when the unit is operating to assist in unit efficiency and water transfer. Adjust the return water valve closed by 10% to create some back pressure within the canister.

IMPORTANT

Electrical

All electrical work should be performed by a fully qualified and licensed electrician in accordance with local electrical codes.

An adequate circuit breaker and copper wiring must be used. Electrical requirements are available on the name plate of the pool heat pump. It may be necessary to install an earth leakage circuit breaker.

Waterco recommend connecting the unit to an isolating switch to allow ease of service and maintenance.

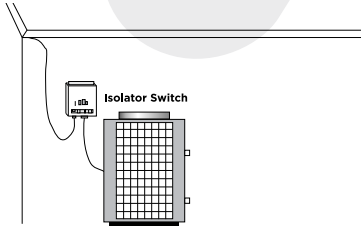

THE POOL HEAT PUMP MUST BE DISCONNECTED BEFORE OPENING THE ACCESS PANEL.

WARNING

Electrical Connection

Standard 60 Hz power supply	: 208/240 v - 60Hz-1 phase
Standard 50 Hz power supply	: 208/240 v - 50Hz-1 phase
3 phase power supply	: 200/230 v - 50/60 Hz - 3 phase
	380/420 v - 50/60 Hz - 3 phase

Single Phase L = Active N = Neutral E = Earth

Three Phase L1 = Phase 1, L2 = Phase 2, L3 = Phase 3, N = Neutral, E = Earth

Breaker Size

Please consult name plate on the base or the side of your pool heat pump for starting amperage and required breaker size.

Electrical Wire Size

Please consult a qualified and licensed electrician.

WARNING

The power cable ground must be connected to the electrical panel and to the ground lug of the pool heat pump. An improper installation may be a potential cause of fire, electrical shock or injury.

Bonding

⚠ VITAL

Because all metals have different electrical potentials, **ALL metal and electrical components of the pool system MUST be bonded together.** This includes the metal framework of the pool, the light, the pump, the filter (if metal), the pool heat pump, any automatic chlorine generator, and any other metal or electrical equipment bonded to your pool.

On some older pools, this substructure bond wire may not exist. In these cases, a 3 - 4 foot solid copper rod must be driven into the ground near equipment; all electric and metal components must be bonded to each other, and to the copper rod. Warranty will be voided if system is not properly bonded.

CAUTION: Some of these systems may leak stray voltage and currents into the water causing severe electrolysis. This dramatically shortens the life of the pool heat pump and will void the warranty.

When an automatic chlorinator is installed on a pool circulation system, it is important the equipment is correctly installed and bonded (earthed). Some systems may leak stray voltage and currents into the water causing severe electrolysis which could shorten the life of the pool heat pump.

NOTE: Bonding to pool pump is not required to above ground pool pumps but all other equipment must be bonded.

Bonding Diagram

⚠ VITAL

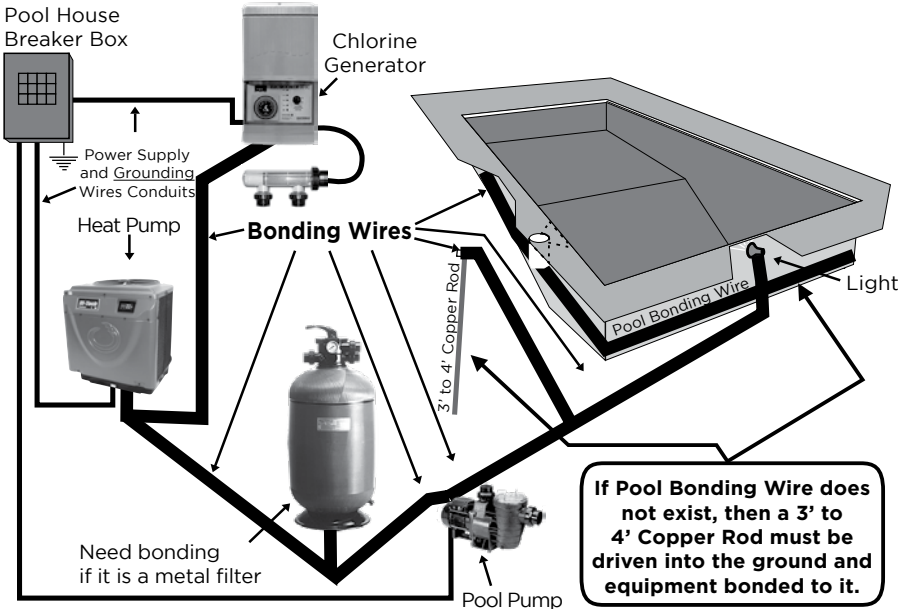

Quick Connector

2 Pin Quick Connector
(pump control)



Side

Top

3 Pin Quick Connector
(automation control)



Side

Top

Connection Overview

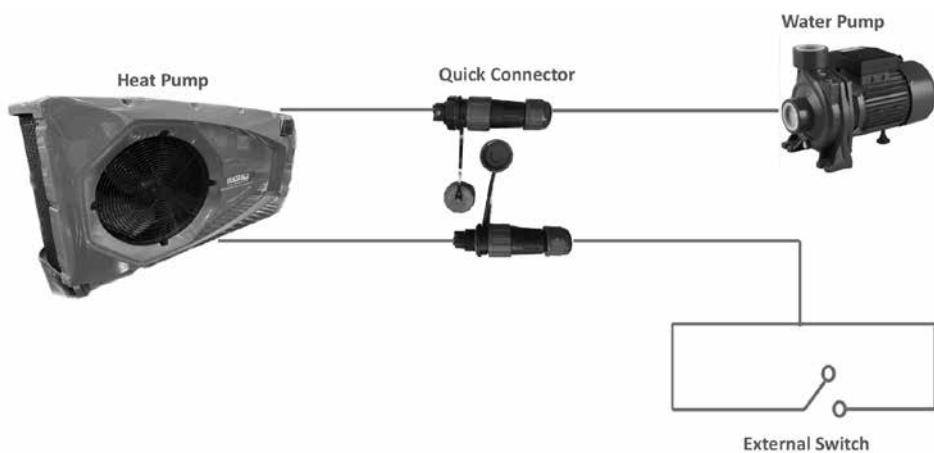

Heat Pump

Quick Connector

Water Pump

External Switch

Wiring Diagram

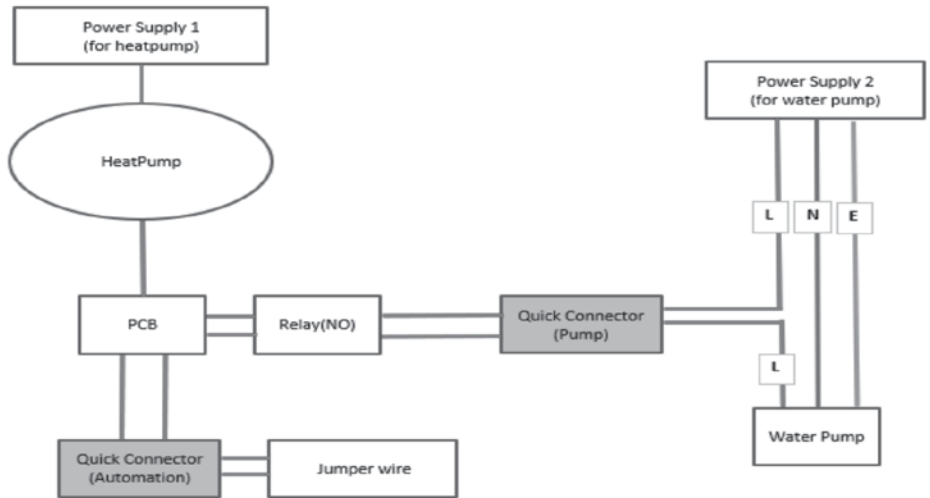

Setting Up Quick Connector For Heat Pump (9kW ~ 22kW)

Out of the box

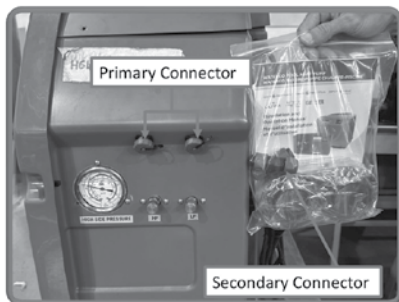

Assemble on site



Note:

1. Primary connector must be joined with secondary connector for the heat pump to operate.

Quick Connector For Heat Pump (25kW ~44kW)

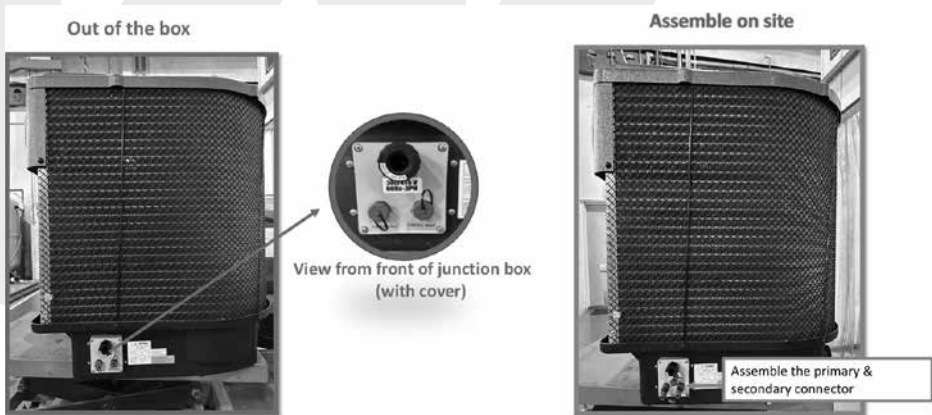

Note:

1. Primary connector must be joined with secondary connector for the heat pump to operate.

Water Pump Control (First time set-up)

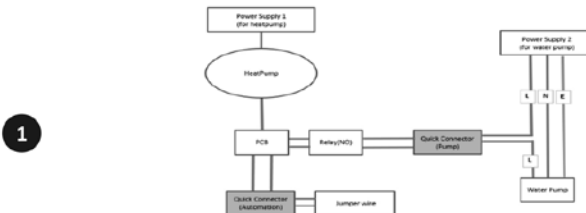

1

- Make sure wire is connected from quick connector to the water pump as per wiring diagram. (refer pg 4)

2



- Power on the heat pump.
- Water pump will not operate and nFL error will appear on the controller display.

Pump Control Sequence

3



- Press & hold **Up, Down** and **°C/F** button to enter setting mode for a few seconds

4



- Starting at **d0** press the **ON/OFF** button to toggle to **dE** then use the **UP** arrow to select **01** pump mode.
00 = Non Pump mode **01 = Pump mode**

5

- Press the **ON/OFF** button to save the setting

6

- Once saved, switch the power to the heat pump off to save the changes and then power the heat pump on.

7



- In pump mode, During heat pump startup the water pump shall run simultaneously.
- Controller display shall show **PU3** to indicate water pump control mode is activated.
- Heat pump compressor will start running after 3mins elapsed.

8

- Water pump will continue to operate until heat pump reaches set temperature and goes into standby mode
- Every 30 minutes water pump will operate to enable heat pump to detect latest incoming water temperature.
- Water pump will then operate based on following condition:
 - ❖ **Run** : If heat pump detects incoming water temperature **lower** than set temp it will continue running the pump.
 - ❖ **Stop**: If heat pump detects incoming water temperature **higher** than set temp it will remain in standby

Quick Connector For Automation Control Setup

1



- To connect two wire automation control open up the cap from secondary connector to find the jumper wire at CONTROL INPUT. Remove the jumper wire and connect the two wires from the automation system heater contact.

2



- If the jumper wire is removed, the heat pump will display (ON) standby mode

Wiring Procedure

3

- Before removing the jumper wire for automation connection, power off the heat pump.
- Complete the automation connection (timer, controller, switch etc)
- Power on the heat pump once the connection is completed.
- Heat pump is now able to be power on/off remotely.

Usage Of Chemical Products

Never add liquid chlorine, granular chlorine, or slow dissolving tablets/ pucks into the skimmer basket. This high concentration of chemicals should be avoided.

Water quality standards that must be strictly adhered to*:

DESCRIPTION	NORMAL RANGE*	VERIFY
PH Level	7.4 to 7.8	1 per week
Chlorine Concentration	1.0 to 4.0 PPM	1 per 2-3 days
Total Alkalinity	100 to 120 PPM	1 per 2-3 weeks
Total Dissolved Solids	Below 1800 PPM <i>Reg. Pool</i>	1 per month
	Below 3500 PPM <i>Salt. Pool</i>	1 per month
Calcium Hardness	200 to 300 PPM	1 per month

* Warranty can be voided if not maintained within these ranges.

Performance Specifications									
	Electroheat MKV					ECO-V	Plus		
Nominal Power Output (kW)*	9	12	14	19	22	12	25	31	44
Nominal Heating Capacity BTU*	30700	41000	51000	64000	78,500	41000	85000	105,000	150,000
Product Code	278095	278123	278152	278192	278232	2781210	2782533	2783133	2784433
Power Output (kW): Air 26C / Water 26C / RH63%	8.9	11.7	13.5	18.5	21.8	11.2 - 6.5	24.5	30.6	43.7
COP	5.9	6.1	6.1	6.3	6.2	4.6 - 7.7	4.9	5.5	5.7
Power Output (kW): Air 15 C / Water 24 C / RH 70%	6.8	9.2	9.4	17.0	20.0	6.0 - 3.0	22.5	28.5	42.0
COP	4.8	4.8	4.3	5.8	5.7	2.5 - 3.6	4.5	5.2	5.4
Supply Voltage (VAC)	230 - 240V/50Hz						400 - 415V / 50Hz		
Supply Voltage Phase	Single Phase						Three Phase		
Power Consumption (kW/h)	1.5	1.9	2.2	3.0	3.5	2.4 - 0.84	5.0	5.6	7.7
Unit Running Amperage (AMP)	8.9	9.1	9.3	15.3	21.2	10.0 - 3.6	12.0	14.0	17.0
Full Load Amps (AMP)	9.0	12.0	12.0	22.0	30.0	15	15.0	17.0	21.0
Minimum Breaker or Fuse (AMP)	16.0	20.0	20.0	30.0	40.0	20	20.0	25.0	32.0
Electrical Connection	10A plug	15A plug	terminals			15A plug	terminals		
Min. / Max . Ambient Air Temperature (C)	10 / 40								
Min. / Max water inlet temp (C)	18 / 40					10 / 40	18 / 40		
Water Connections (mm)	40mm slip								
Bypass	External 3 x 2 way								
Evaporator area m2	0.59	0.59	1.18	1.77	1.77	0.74	1.22	1.63	
Min / Max Water Flow Rate LPM	120 - 230					115 - 160	120 - 230	132 - 303	
Unit Dry Weight (kg)	51	55		79		43	84	87	93
Dimensions W x L x H (mm)	1269 x 361 x 717					636 x 714 x 973	750 x 850 x 1000	890 x 880 x 1130	
Refrigerant	R410A								
Heat Exchanger Max. Pressure	3.5 bar / 350 kPa								
Mode	Heat					Heat / Cool	Heat		

Setting up WIFI and app

1. Install the Waterco Connect app



In order to monitor and control your Electroheat unit, first download Waterco Connect on your phone or tablet.

You can scan the QR code below to take you straight to the right app store.

iPhone and iPad



App Store



Android



Google Play



2. Pair your Electroheat to your app

Make sure your Electroheat is powered on for at least 60 seconds before connecting to it from the app.

Step one

Open and sign in to Waterco Connect



Step two

Press ADD DEVICE to start the connection wizard.

Step three

Follow the pairing wizard to connect to your Electroheat and pair it with your account.

You will need to locate the QR code sticker on the side of your Electroheat and scan it with your camera when the wizard tells you.

You will also need to know your home Wi-Fi network name and password to complete the pairing.

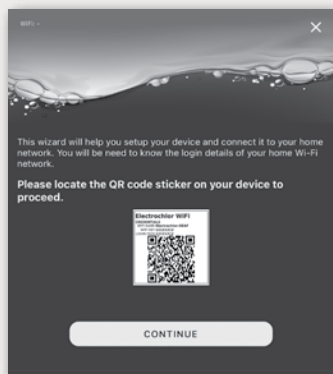

Step four

Your Electroheat will now appear on your dashboard.

Press on the device card and it will open up the Electroheat info and settings page.

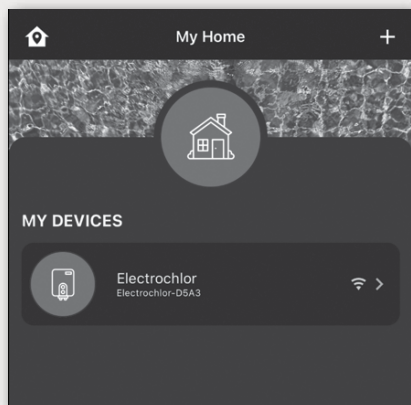

3. Troubleshooting

The Waterco Connect pairing wizard couldn't find my Electroheat?

Try power cycling your Electroheat unit - turn it off for 10 seconds and then turn it on again. Please wait at least 60 seconds for the Electroheat to fully power up before running the pairing wizard. Make sure you are within a few meters of the unit when you run the wizard. If Waterco Connect still cannot find your Electroheat after scanning the QR code sticker please contact Waterco support.

My Electroheat is unable to join my home Wi-Fi network?

Please make sure you know your home Wi-Fi network details. Double check the name (sometimes called SSID) of your network and triple check the password is correct. Sometimes there are sneaky capital letters! If you are sure that your network details are correct then it could be possible that the location your Electroheat is installed in cannot reach the Wi-Fi signal from your router. If you think this is the case then contact Waterco support.

OPERATION OF YOUR POOL HEAT PUMP

Initial Heating

To achieve initial heating, your pool heat pump and the pool pump may require extended operation until desired temperature is achieved. The initial heating time may vary depending upon the five factors listed below. After initial heating, operating time may be reduced to match daily heat loss.

1. Size of the pool.
2. How many degrees the water is to be heated.
3. Ambient air temperature - the warmer the air, the less time required to heat.
4. Use of a solar blanket .
5. The size of the pool heat pump.

Atmospheric conditions as well as the pool water temperature should not be below the minimum operating temperatures as stated below in order to obtain efficiency and avoid codes from appearing on the electronic control temperature display ; these codes are not generally a problem with the pool heat pump at these conditions and is not covered by the warranty.

If a combination of the atmospheric and water temperatures are below the minimum listed concurrently the pool heat pump should not be operated and be switched off.

Generally, atmospheric conditions (air temperature) will be warmer during day time hours. To accelerate the initial heating period owners may opt to increase the ambient air temperature artificially around the evaporator area of the pool heat pump until the pool water temperature has reached the minimum required as stated below.

For Electroheat Ultra, Inverter and Reversible (XLR) units, they will automatically stop without human intervention.

Model	Atmospheric conditions must be above	Pool water temperature must be above
Electroheat Ultra	32°F (0°C)	50°F (10°C)
Reversible (XLR) and Inverter	43°F (6°C)	65°F (18°C)
All others	52°F (11°C)	65°F (18°C)

Adjustment Of The Bypass Valves

The adjustment may vary according to pool pump size and ambient temperatures.

ATTENTION: IT IS VERY IMPORTANT THAT THE BYPASS VALVES ARE SET AS DESCRIBED BELOW FOR THE CORRECT FUNCTION OF YOUR POOL HEAT PUMP

VALVE POSITION

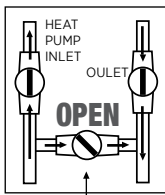

When the pool water temperature is between 65°F (18°C) and 70°F (21°C) please adjust the bypass valve as shown. Approx. 60% of the water is circulating in the unit.

VALVE POSITION

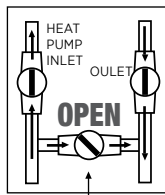

When the pool water temperature is between 70°F (21°C) and 78°F (26°C) please adjust the bypass valve as shown. Approx. 80% of the water is circulating in the unit.

VALVE POSITION

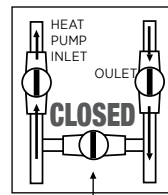

When the pool water temperature is above 79°F (26°C) please close the bypass valve as shown. 100% of the water is circulating in the unit.

Pool Heat Pump Running Time

Most units should be sized to operate during the pool filtering cycle time of 8-12 daytime hours daily during warmer months and up to 8 hours daily during the daytime in winter months. On warmer days the pool heat pump will run less because the heat loss will be less.

IMPORTANT

Condensation

Your pool heat pump will accumulate condensed water (approx. 1 to 1.5 gallons or 4 to 6 litres per hour), therefore causing water to drain out of the unit base. In order to avoid water accumulation, you may use decorative rocks around the concrete slab or a basin under the unit. *(Please note this is a normal characteristic of a pool heat pump and not a service or warranty issue.)*

Pool Solar Blanket

A pool solar blanket should be used whenever possible. Blankets minimize heat loss through evaporation and conserve heat in your pool. Un-blanketed pool can lose 2-3 times more heat than a blanketed pool.

Defrost Cycle

When any of the following conditions occur the electronic control of your unit will activate a defrost mode until all frost from the evaporator has melted. Condensation of water on the evaporator coil tends to frost up quicker when the following occur.

1. When atmospheric conditions are as stated above;
2. When the evaporator is dirty;
3. When installation clearances are not respected.

Defrost is activated for between 3 to 20 minutes.

CONTROLLER TYPES (Fixed Speed Models)

Electronic Control with Diagnostics for Standard Models and Electronic Control with Diagnostics for Reversible de-icing Models

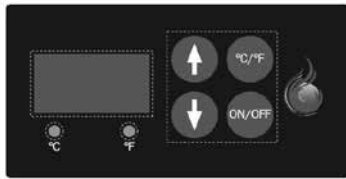

**Electronic Control
with diagnostics**



**Reversible (XLR) electronic control
with diagnostics**

To Start The Pool Heat Pump

Press the button on the electronic control ON/OFF to start the pool heat pump. The temperature display will show the pool water temperature flowing in your pool heat pump and the fan motor starts (fan blade turns) but the compressor does not start.

The temperature display flashes until the compressor starts and when the timer will complete its cycle of 3 to 5 minutes. After 5 minutes, the compressor starts and the temperature on the display stops flashing.

You can now program the desired temperature for the pool water.

To Stop The Pool Heat Pump

The pool heat pump can be stopped by pressing the **ON/OFF** button once.

To Check and Adjust Temperature Settings

To program the desired water temperature, press BOTH the UP and DOWN arrow keys at the same time until the temperature degree displays change degree, then release them.

Press the UP arrow or DOWN arrow to program the desired temperature. The temperature setting will automatically flash and will be saved. The display temperature will be revert back to the pool water temperature when all keys have remained untouched for 5 seconds.

To change the temperature display from Fahrneheit (°F) to Celcius (°C). Press, the button °C/°F. The led below the °F or °C will be lit to indicate the current selection.

Note: The pool heat pump will cut out at once when the programmed temperature has been reached.

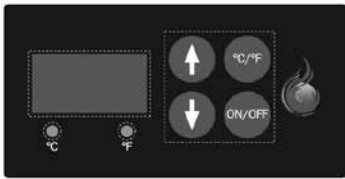

**Electronic Control
with diagnostics**

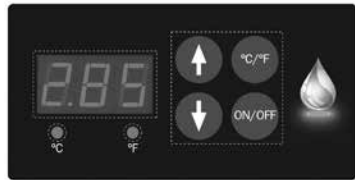

**Reversible (XLR) electronic control
with diagnostics**

In addition to controlling the temperature of the water, this electronic control informs you on the operation of your pool heat pump or any faults that may arise by displaying codes on the temperature display.

When the unit is in defrost mode the code **"DEF"** is displayed on the temperature display. This under normal conditions is not considered to be a fault.

Temperature Calibration

It is possible to have a temperature variation between the water in the swimming pool and the reading of the pool heat pump temperature probe (sensor).

Example: if the water in the pool is 26° C (80° F) and the heat pump electronic control displays 24°C (76° F).

To calibrate this variation, perform the following procedure:

1. With the use of an accurate thermometer read the pool water temperature (e.g: 26° C).
2. Read the temperature displayed on the pool heat pump electronic control (eg: 24° C).
3. To determine the differential subtract the pool water temperature from the pool heat pump displayed temperature, $26 - 24 = 2^{\circ}\text{C}$. Therefore we must compensate for the 2° C variation.
4. Press **BOTH** the **UP** and **DOWN** arrow keys until the programmed temperature is displayed (the temperature you have previously set) then release both buttons.
5. Press the **ON/OFF** button and release.
6. Using the UP and DOWN arrows, enter the calibration value, (2° C). In this case, by pressing the UP arrow twice.
7. After 5 seconds when all the buttons have remained untouched , the display temperature will show the pool water temperature as per your thermometer. If this is the case the calibration process was successful.

To Change Display From Farenheit To Celcius

1. Press and release the SET key until **F-C** appears on the temperature display.
2. Whilst **F-C** is still on the display Press and release the **UP** or **DOWN** arrow key until C is displayed.
3. Release all keys and the control will now be set for Celcius. (do not press any other keys for 5 seconds)

To go back to Farenheit follow the same instructions above, however when you are at step 2, F will need to be shown on the display before releasing all keys.

Defrost for Electroheat Ultra

During the defrost cycle, the fan motor stops working and the hot gas is injected into the evaporator to melt the frost. However, when the pool heat pump makes 5 consecutive cycles (heating and defrost) in less than 15 minutes, the unit goes into protection mode to avoid inefficient use of electricity. These frequent defrost cycle's mean that the conditions of ambient temperature and humidity do not allow to heat your pool water. The FS4 code will be displayed on the electronic control. Refer to the section titled " Service Analyser Codes " to validate what you should do.

Protection Devices

The integrity and performance of your pool heat pump and its components are protected by internal safety controls. In normal use, your Waterco unit should never reach the thermal protection level. However, if it should happen, you should identify the stated code on the temparature display and refer to Service Analyser codes.

Codes

If a code appears on the electronic control refer to Service Analyser codes (all standard models) on page 29.

Inverter Pool Heat Pump Controller

This controller applies to DC inverter air source pool heat pumps, for heating.



Heating



Automatic Mode



Clock/ Timer/ Function Display



Clock Adjustment Icon



On Timer Icon



Off Timer Icon



Temperature Display - the numerals on the left side indicate the set water temperature. The numerals on the right side of the display indicate the pool water temperature.



Temperature Icon (in degree Celsius)



Function Settings Icon



Keypad button lock is active



Real-time Temperature Distinction Icon



Set Temperature Icon



When heating mode is selected the units operating speed is indicated as follows - one bar - low speed, two bars - medium speed and three bars - high speed. The unit also has an AUTO mode where the units heating rate is automatically selected according to the air, set and pool water temperatures.



Inverter Controller Operation

Button functions are as indicated below:

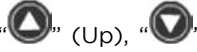

“” button: Press briefly then release to switch the machine on/off, press 3 seconds to lock or unlock buttons.



“” (Up), “” (Down) buttons: To set temperature, off timer, to increase or decrease parameters.



“” button: Press briefly then release for on and off timer functions, press 3 seconds to set clock.



“” button: Press briefly then release to set low-auto when set to heat, intermediate-frequency, high-frequency and auto when set to heat.



“” button: Press 3 seconds to switch between cooling, heating and automatic mode.

Timer Function

1. A 24hr timer function is included in the units controller which may be set in one minute increments.
2. On timer function: - When the heat pump is switched off, enter the settings menu and set the on timer to switch the unit on automatically.
3. Off timer function: - When the heat pump is switched on, enter the settings menu and set the off timer to switch the unit off automatically.
4. The timer function may repeat and is only deactivated when the ON / OFF button is selected.
5. Timer error is less than 1min/h.

Note: Timer time is calculated based on Clock time.

Function Descriptions

1. When power to the unit is switched on the controller display will illuminate.
2. Use the UP and DOWN arrow buttons on the keypad to adjust. Adjustable functions: For users, the current temperature, flash, “ ” and “ ” to adjust, press ON/OFF button to return to the current status. To fully adjust cooling, heating, automatic temperature, users need to enter cooling, heating and automatic mode respectively for adjustment.
3. In auto mode, the units operating speed is displayed on screen.
4. Backlight will be illuminated when buttons are pressed. Backlight will be turned off if button is not pressed in 1 minute.

Buzzer

Under any operation, a buzzer will sound when any button on the keypad is pressed. When the unit reports a fault the buzzer will be silent and the code will be displayed on the controller screen.

Memory Function

The heat pump controller should memorise ON / OFF status, operating mode, parameter and timer settings. When power is connected and the heat pump is switched on, the unit will start operation based on the settings when power was switched off previously.

MAINTENANCE OF YOUR POOL HEAT PUMP

Waterco pool heat pumps have been specifically engineered to give you years of satisfaction and enjoyment in the pool.

Cabinet Cleaning

To clean the plastic surfaces use mild soapy water and a soft clean cloth. Never use solvents or abrasives.

Cleaning Evaporator

The evaporator at the rear of the unit must be kept clean and un-obstructed in order for your pool heat pump to have better efficiency and avoid problems which may void your warranty. The dirt collected in the evaporator can be removed with a gentle water spray and the use of a soft brush. Be careful not to damage the aluminum fins.

Cleaning drainage holes

The condensate drainage holes in the base of the unit must be kept free of debris. Blocked drainage holes may cause water to collect in the unit and become stagnant or, interfere with electrical components and wiring.

Issues caused by blocked drainage holes in the base of the unit are not covered under warranty.

Units Located In Coastal Locations

Care and maintenance procedures for Waterco Pool Heat Pumps installed in coastal locations.

Exposure to salt may result in evaporator coil damage shortening the life of the equipment.

Bare aluminium fins can deteriorate rapidly depending on a number of factors including fin design, location of the equipment relative to salt water, and maintenance.

For Waterco pool heat pumps located within one kilometre from the coast a coating must be applied to the unit prior to site delivery on the evaporator fins and exposed metal surfaces to reduce the incidence of corrosion.

A monthly rinse with potable water straight from the garden hose connected to the municipal water system to remove the salt build up on the evaporator coil and exposed metal surfaces is necessary.

Winterising Procedure

VITAL

If the pool heat pump is stored in a place where the temperature drops below the freezing point of 0 °C (32°F); it is **mandatory that the water accumulated in the pool heat pump be drained completely before freezing weather prevails. Improper winterizing may damage the pool heat pump and will void the warranty.**

- Turn the pool heat pump “**OFF**”.
- Turn the pool heat pump breaker “**OFF**”.
- The water piping **MUST** be disconnected to drain the pool heat pump’s heat exchanger in preparation for winter.
- Once the piping is disconnected, the pool heat pump’s heat exchanger **MUST** be emptied; the use of a water vacuum cleaner is strongly recommended or if you do not have this tool you may tilt the unit (75°) until all the water is out.
- It is recommended that pool heat pump’s heat exchanger is rinsed out with a gentle water spray at the inlet and outlet water connections of the pool heat pump and then drain the heat exchanger again.
- With the help of 2 pool return winter plugs, block the water Inlet and Outlet connections to prevent access by vermin.
- Clean the drainage holes located at the bottom of the base of the unit.
- Unit may be covered for the winter.
- It is also possible to fill the heat exchanger with pool anti-freeze, but ensure that the antifreeze contains an elevated pH to prevent corrosion. This is optional and requires appropriate hardware.

GENERAL SAFETY INSTRUCTIONS

DO NOT DEPRIVE YOUR POOL HEAT PUMP OF WATER FLOW FOR MORE THAN 24 HOURS WITHOUT DRAINING IT. Make sure you leave the bypass valves as shown in Figure 1.

At the end of each season, when the pool heat pump is no longer in use, and proper pool water chemistry is not maintained, it should be disconnected from the water line and drained to prevent any possible corrosion or damage to the pool heat pump. Refer to Figure 1 below or winterising procedure (page 24).

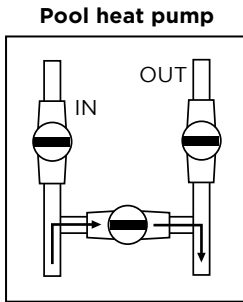

When your valves position are as shown on Figure 1, the water is bypassing the pool heat pump.

Figure 1

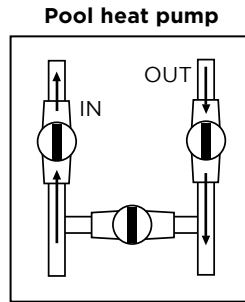

When your valves position are as shown on Figure 2, the water is going through the pool heat pump.

Figure 2

The valves shown above may be different to the ones installed on your system. Please ensure you understand how your bypass valve operates.

TROUBLESHOOTING

Please ensure the unit and any related equipment is installed in accordance with the installation manual. If not, the Waterco warranty will not apply and the customer may be liable for service call charges.

Nothing Is Working And The Electronic Control Does Not Operate

1. Ensure the circuit-breaker has not tripped and/or the fuses have not blown;
****Take note that only an electrician can verify if the circuit breaker is defective; if this is the case, repairs will not be covered under the warranty.**
 2. For three phase models, this situation could occur when phases are not in the appropriate order. The green led light on the front panel will not light up.
Please have a qualified electrician swap over two of the incoming phase wires.
-

Nothing Is Working But The Electronic Control Temperature Displays Digits Or A Code

1. Identify the analyser code that the electronic control displays and refer to the Service Analyser codes section;
2. If the electronic control displays digits, make sure that the electronic control is programmed correctly, refer to the Operation of your pool heat pump and reprogram if necessary.

***Note that this situation could occur when the electrical voltage is not respected as stated on the pool heat pump name plate. This situation is not covered by the manufacturer warranty.*

Fan Doesn't Work (the fan blades are not moving)

1. **IMPORTANT:** For safety, switch OFF the circuit-breaker.
2. Try to rotate the fan blades of the fan with a rod to see if the motor is jammed or seized
3. If the fan blades do not turn freely leave the unit switched OFF and call for service;
4. If the fan blades turn freely switch ON the circuit breaker and the pool heat pump again.

*** Note that your fan motor may have an electrical fault if the blades turn freely when the unit is switched OFF and does not start when the unit is switched ON.*

Fan Blades Turn, But Compressor Is Not Functioning

The pool heat pump has a built in delay timer which prevents the compressor from starting immediately. The delay can be 3 to 5 minutes in duration after the fan blades have turned. Furthermore if the unit is in defrost mode the compressor will not start for 3 to 20 minutes.

1. Check that air being discharged from the fan blades is colder than the ambient air. If the air being discharged by the fan blades is colder, it means that the compressor is functioning correctly.
2. Turn off the pool heat pump then immediately turn it back on;
3. As soon as the fan blades start turning, wait a minimum of 3-5 minutes. The compressor should start up after this time and you will be able to identify a different sound made by the compressor when it starts;
4. If the compressor is functioning, but shuts off immediately, consult the following section " Compressor Starts and Stops ".
5. If the problem persists, call your local Waterco office for assistance.

Compressor Starts And Stops

1. Check that the unit has been installed correctly (refer to installation procedures).
2. Check that the water inlet and outlet of the unit have not been connected incorrectly.

There Is Water Around The Pool Heat Pump

It is a normal occurrence for water condensation, to be seen running from the unit base. There will be on average 1 to 1.5 gallons (4 to 6 litres) of condensed water per hour being discharged from the unit base. In order to avoid water accumulation, you may use decorative rocks around the concrete slab or a basin under the unit. Be sure that clearances around the unit are respected.

To test the unit and confirm you have no pool water leaking from the unit perform the following test which is best performed early in the morning and continuing for the whole day:

1. Turn off the pool heat pump from the circuit breaker and the pool pump.
2. Open the bypass valve. (refer to drawing on page 5)
3. Close the **IN** and **OUT** water valves on the unit.
4. Restart the pool pump. The pool heat pump must remain **OFF**.
5. When all of the water around the base of the pool heat pump has dried, open the water **IN** and water **OUT** valves on the pool heat pump.
6. Close the bypass valve to allow full water flow through the pool heat pump.

If water is now seen running from the outside of the pool heat pump or inside the pool heat pump after a short period of time you should call for service. If no water is seen after a short period of time it would be assumed the water was condensation which is normal.

Pool Heat Pump Has Ice Formed On The Evaporator Coil

1. **IMPORTANT:** For safety, switch OFF the circuit-breaker.
2. Allow the ice to melt and then inspect the evaporator to ensure it is free of debris and leaves.
3. If the evaporator is dusty or dirty, clean it with a light spray of water and allow it to dry (do not use high pressure it may damage the evaporator fins).
4. When the unit is dry, you may switch it back ON from the circuit breaker.
5. Ensure that the clearances around the unit are respected.
6. When the unit has been switched ON ensure the fan motor is working (fan blades will be turning) while the compressor is operating.
7. If the fan blade does not turn and the compressor is functioning; notify customer service.

***If the pool heat pump requires service, the owner of the pool heat pump will need to ensure the unit has been switched OFF to allow any ice to melt prior to any technician attending.*

Pool Heat Pump Is Functioning, But Does Not Reach The Desired Temperature Setting

IMPORTANT

Improper installation may cause this situation and will need to be corrected by the owner.

1. Ensure the by-pass valves are in the correct positions to ensure sufficient water flow, insufficient water flow will cause the compressor to shut off early.
2. If you have installed a timer or the pool heat pump is equipped with an integrated timer, be sure it is programmed to allow the pool pump to work for sufficient time in order to reach the programmed temperature.
3. Ensure the evaporator is cleaned regularly with a light spray of water and allowed to dry before re-starting the pool heat pump to avoid premature ice build up on the evaporator.
4. Waterco recommend the use of a solar cover to retain heat in pool water. Pools without covers lose 2 to 3 times more heat than pools with solar covers.
5. Make sure the electronic control of your pool heat pump has been programmed correctly; during this test the pool heat pump and water pump must be working continuously (eg; the desired water temperature must be set correctly).
6. If the unit continually fails to reach the desired water temperature, we suggest completing the following analysis chart and forwarding it to Waterco in order to avoid unnecessary service fees.

Analysis Chart

Important: Please record all information for three consecutive days at 12h00	Day 1	Day 2	Day 3
---	--------------	--------------	--------------

Outside air temperature			
Weather conditions outside (eg: cloudy, sunny or rainy)			
Pool water temperature**Use a pool thermometer			
Pool water temperature **use the reading from the electronic control on the pool heat pump			

Important: Please record all information for three consecutive days at 20h00	Day 1	Day 2	Day 3
---	--------------	--------------	--------------

Outside air temperature			
Weather conditions outside (eg: cloudy, sunny or rainy)			
Pool water temperature**Use a pool thermometer			
Pool water temperature **use the reading from the electronic control on the pool heat pump			

Circuit Breaker Trips

 **IMPORTANT**

If you have purchased a remote control (or other equipment), ensure the equipment is correctly installed. If an operational issue originates from incorrect operation or installation of this equipment, Waterco's warranty will not apply and you will have to pay the cost of the service call.

1. The amperage of the circuit breaker AND the electrical wiring must be as the instructions on the pool heat pump name plate, otherwise notify your installer or electrician to correct this problem, as this is not covered under the warranty.
 2. If the circuit breaker and electrical wiring are as stated, make sure the drains, located on each side of the base of the pool heat pump are not obstructed.
-

The Pool Heat Pump Is Noisy

1. Check the pool heat pump is level and on a solid base to prevent any vibrations issues.
 2. Ensure the noise is coming from the pool heat pump, not from other equipment which will not be covered by the warranty (for example: noise coming from the bypass valve, pool pump, etc);
 3. An improper installation may cause this situation it will need to be corrected by the owner.
-

The Temperature Shown On Pool Heat Pump Is Not The Same That Is Shown By The Pool Thermometer

It is possible to have a temperature variation between the temperature shown on the electronic control temperature display of the pool heat pump and a pool thermometer which may be read from different locations. Please refer to the temperature calibration section in order to adequately recalibrate temperature if required.

- Check that there are no leaks on the pool plumbing (there should be no air leaks in the pipework);

Service Analyser Codes (Standard Models)

Most operating issues will be detected by the electronic control and a code will appear on the temperature display. Ensure the Action / Remedy suggestions are followed prior to booking a service call and avoid unnecessary call out fees. If the code remains on the display after you have followed the Action / Remedy instructions, please contact Waterco.

Code	Problem - Action / Remedy
dPd, oC2, Sc2	<p>Problem: The air intake temperature defrost probe has a loose connection or is faulty. The probe will need to be checked (defrost probe), and replaced if required.</p> <p>Action / Remedy: Contact customer service.</p>
FLo, FL3 nFL	<p>Problem: No water flow, not sufficient water flow through the pool heat pump or the water pressure switch needs to be adjusted or is defective.</p> <p>Action / Remedy: If the pool pump is connected to the pool heat pump make sure the electronic control that runs the pool pump and pool heat pump are programmed correctly</p> <p>If the code is still displayed:</p> <ul style="list-style-type: none"> - Make sure the pool pump is switched ON; - Press "SET" or "ON/OFF" depending on the model, to restart the pool heat pump; - On new installations, ensure the installation instructions were respected; - Check that the pool water level is correct, that the pool pump is filled with water to the rim and that water is flowing correctly through the pool pump to the pool heat pump; - Check swimming pool and pool pump skimmer baskets and the drain at the bottom of the pool for obstructions; - Check the filter cartridges for obstructions (wash or change the cartridges); - Carry out a backwash for sand filters and ensure they are working correctly; - Ensure that the bypass valves are in the correct positions so that the water flows adequately; - Ensure vacuum robot or other cleaners are disconnected so that the water flows freely. - Check that there are no leaks on the pool plumbing (there should be no air leaks in the pipework);

Code	Problem - Action / Remedy												
FS, DEF, FS4	<p>Problem: Normal defrost cycle. The fan blades are turning, but the compressor has stopped. For Electroheat Ultra and Reversible model, the fan blades do not turn but the compressor runs.</p> <p>Action / Remedy: Normal during defrost duration. Atmospheric conditions as well as the pool water temperature should not be below the minimum operating temperatures as stated below in order to obtain efficiency and avoid codes from appearing on the electronic control temperature display ; these codes are not generally a problem with the pool heat pump at these conditions and is not covered under warranty.</p> <p>If temperatures are below the minimum temperatures the pool heat pump should not be operated and must be switched off.</p> <p>For Electroheat and Reversible (XLR) units, they will automatically stop without human intervention.</p> <table border="1" data-bbox="277 619 985 799"> <thead> <tr> <th data-bbox="277 619 538 699">Model</th> <th data-bbox="538 619 762 699">Atmospheric conditions must be above</th> <th data-bbox="762 619 985 699">Pool water temperature must be above</th> </tr> </thead> <tbody> <tr> <td data-bbox="277 699 538 730">Electroheat Ultra</td> <td data-bbox="538 699 762 730">32°F (0°C)</td> <td data-bbox="762 699 985 730">50°F (10°C)</td> </tr> <tr> <td data-bbox="277 730 538 762">Reversible (XLR)</td> <td data-bbox="538 730 762 762">43°F (6°C)</td> <td data-bbox="762 730 985 762">65°F (18°C)</td> </tr> <tr> <td data-bbox="277 762 538 799">All others</td> <td data-bbox="538 762 762 799">52°F (11°C)</td> <td data-bbox="762 762 985 799">65°F (18°C)</td> </tr> </tbody> </table> <p>For Electroheat model: If the unit carries out 5 consecutive defrost cycles every 15 minutes or less, the pool heat pump is then put into protection mode (FS4). During this mode, the fan blade turns for 30 minutes in order to cool the evaporator. The pool heat pump restarts automatically when the external temperature is at: 34°F (1°C).</p> <p>For Reversible (XLR) Model: If the unit performs 4 consecutive cycles (heating and defrost) within 1-hour, the unit goes into protection mode and alternately displays the water temperature and the DEF code. The fan motor runs for 30 minutes to cool the evaporator and then stops. The compressor is always off. The unit restarts automatically when the outside temperature is 43°F (6°C) and more.</p> <p>If the code stays on permanently:</p> <ul style="list-style-type: none"> - Ensure the evaporator is clean. If not switch the unit OFF from the circuit breaker (fuse) and use a garden hose to lightly clean the evaporator, then allow it to dry before re-starting the pool heat pump to avoid premature ice build up on the evaporator. - Ensure installation instructions have been followed, Improper installation, e.g. no air circulation could lead to the pool heat pump continually going into defrost mode and the installation will need to be corrected by the owner. 	Model	Atmospheric conditions must be above	Pool water temperature must be above	Electroheat Ultra	32°F (0°C)	50°F (10°C)	Reversible (XLR)	43°F (6°C)	65°F (18°C)	All others	52°F (11°C)	65°F (18°C)
Model	Atmospheric conditions must be above	Pool water temperature must be above											
Electroheat Ultra	32°F (0°C)	50°F (10°C)											
Reversible (XLR)	43°F (6°C)	65°F (18°C)											
All others	52°F (11°C)	65°F (18°C)											

Code	Problem - Action / Remedy												
<p>LP, LP3</p>	<p>Problem: Low refrigerant level in the pool heat pump or the low-pressure safety control is defective.</p> <p>Atmospheric conditions as well as the pool water temperature should not be below the minimum operating temperatures as stated below in order to obtain efficiency and avoid codes from appearing on the electronic control temperature display ; these codes are not generally a problem with the pool heat pump at these conditions and is not covered by the warranty.</p> <p>If temperatures are below the minimum temperatures listed below the pool heat pump should not be operated and must be switched off.</p> <table border="1" data-bbox="316 547 1022 729"> <thead> <tr> <th data-bbox="316 547 577 630">Model</th> <th data-bbox="577 547 799 630">Atmospheric conditions must be above</th> <th data-bbox="799 547 1022 630">Pool water temperature must be above</th> </tr> </thead> <tbody> <tr> <td data-bbox="316 630 577 662">Electroheat Ultra</td> <td data-bbox="577 630 799 662">32°F (0°C)</td> <td data-bbox="799 630 1022 662">50°F (10°C)</td> </tr> <tr> <td data-bbox="316 662 577 694">Reversible (XLR)</td> <td data-bbox="577 662 799 694">43°F (6°C)</td> <td data-bbox="799 662 1022 694">65°F (18°C)</td> </tr> <tr> <td data-bbox="316 694 577 729">All others</td> <td data-bbox="577 694 799 729">52°F (11°C)</td> <td data-bbox="799 694 1022 729">65°F (18°C)</td> </tr> </tbody> </table> <p>Action / Remedy:</p> <ul style="list-style-type: none"> - If the LP or LP3 code is shown permanently, press “SET” or “ON/OFF” depending of the model you have before to get to next step; - Ensure the evaporator is clean. If not switch the unit OFF from the circuit breaker (fuse) and use a garden hose to lightly clean the evaporator, then allow it to dry before re-starting the pool heat pump to avoid premature ice build up on the evaporator. - Ensure installation instructions have been followed. Improper installation, e.g. no air circulation could lead to the pool heat pump continually going into LP or LP3 mode and the installation will need to be corrected by the owner. 	Model	Atmospheric conditions must be above	Pool water temperature must be above	Electroheat Ultra	32°F (0°C)	50°F (10°C)	Reversible (XLR)	43°F (6°C)	65°F (18°C)	All others	52°F (11°C)	65°F (18°C)
Model	Atmospheric conditions must be above	Pool water temperature must be above											
Electroheat Ultra	32°F (0°C)	50°F (10°C)											
Reversible (XLR)	43°F (6°C)	65°F (18°C)											
All others	52°F (11°C)	65°F (18°C)											
<p>HP, HP3</p>	<p>Problem: Low water circulation in the unit or the high-pressure control is defective. If the HP code is triggered and displayed 3 times; this will cause the pool heat pump to shut down automatically. The HP3 code will then appear permanently (except for reversible electronic control with diagnostics). Note: The pool pump will stop functioning only if the internal time delay of the pool heat pump is being used.</p> <p>IMPORTANT: When the code HP3 is permanently displayed, before performing the steps below, please press the “SET” button for the electronic control Multi Function and “ON / OFF” for the electronic control with diagnostics and the reversible electronic control with diagnostics (XLR) and electronic control with diagnostics.</p>												

Code	Problem - Action / Remedy
HP, HP3	<p>Action / Remedy: Make sure the water reaches the pool heat pump and the pool pump is completely filled to the rim. Otherwise:</p> <ul style="list-style-type: none"> - Fill the pool pump with water, and check to see if the pipes between the pool pump and the pool are watertight (there should be no air intake); - Check the swimming pool and pool skimmer baskets and the drain at the bottom of the pool for obstructions; - Check the filter cartridges for obstructions (wash or change the cartridges, as the case may be); - Insure that the bypass valves are in the correct positions so that the water flows adequately; - Backwash sand filter (insure that there is a sufficient amount of sand and verify that it does not have to be changed. Consult a swimming pool specialist if necessary); - Make sure the vacuum robot is disconnected so that the water flows freely.
OFF	<p>Problem: The desired water temperature setting programmed is below 60°F (15°C) for the Multi function electronic control OR the electronic control with diagnostics is OFF or could be defective.</p> <p>Action / Remedy: Reprogram the desired water temperature setting to a higher setting for the electronic control with Multi Function. For the electronic control with diagnostics and the reversible electronic control with diagnostics (XLR), press on key "ON/OFF".</p>
PSD, oC1 & Sc1	<p>Problem: The water temperature probe has a loose connection or is faulty. The probe will need to be checked and replaced if required.</p> <p>Action / Remedy: Contact customer service.</p>
ot	<p>Problem: Water temperature is higher than 45°C (113°F) within the unit (this code is only displayed on the electronic control with diagnostics).</p> <p>Action / Remedy:</p> <ul style="list-style-type: none"> - Make sure the bypass valves are in the correct positions; - Proceed to the calibration of the electronic control with diagnostics and reversible electronic control with diagnostics (XLR).

Service Analyser Codes (Inverter Models)

Code	Action
EE 01	High-pressure Failure
EE 02	Low-pressure Failure
EE 03	Water Flow Failure
EE 04	Heating Water Temperature Overheating Failure
EE 05	Exhaust Temperature Failure
EE 06	Wired Controller EEPROM Data Read/Write Failure
EE 07	Converter Board EEPROM Data Read/Write Failure
EE 08	Wired Controller and Converter Board Communication Failure
EE 09	Converter Board and Outdoor Board Communication Failure
EE 10	Outdoor Board and Module Board Communication Failure
EE 11	Module Board Failure
EE 12	DC Bus Overvoltage, Low-Voltage Protection
EE 13	Overcurrent Protection
EE 31	Outdoor DC Fan Failure (only for DC Fan Model)
PP 01	Inlet Water Temperature Sensor Failure
PP 02	Outlet Water Temperature Sensor Failure
PP 03	Outdoor Coil Sensor Failure
PP 04	Return Air Sensor Failure
PP 05	Outdoor Environment Sensor Failure
PP 06	Compressor Exhaust Sensor Failure
PP 07	Winter Antifreeze Protection
PP 08	Low Ambient Temperature Protection
PP 09	Heating Ambient Temperature Overheating Protection
PP 10	Cooling Outer Coil Overheating Protection
Defrosting	Defrosting Indicator Heating Icon Flash Prompt

WARRANTY

1. Waterco's obligation to repair or replace at Waterco's option, shall be the original purchaser's sole and exclusive remedy under this warranty. Waterco shall not be liable for incidental, consequential or special damages arising out of or in connection with product use or performance.
2. Waterco is not responsible for direct or indirect damages resulting from defective components. This warranty gives you specific legal rights and you may also have other rights, which vary from state, province or country to another.
3. Prior to contacting Waterco for assistance or service, please check the "Troubleshooting" and the information stated in this section.
4. Warranty will only cover manufacturing defects. All service call requests which are not of this nature must be paid by the purchaser to the service company authorized by Waterco.
5. All services will be handled by the authorized service company. Warranty may be voided if service is not carried out by a Waterco authorised service agent.
6. DO NOT return the pool heat pump to your dealer as they do not provide the service work.
7. Prior to contacting Waterco for assistance or service, in order to qualify for a warranty claim, the original purchaser must have the model name and serial number along with a proof of the original purchase date. Proof of purchase must be forwarded to Waterco and they will inform you of the applicable warranty.
8. Once connected with a Waterco customer service agent, proceed to describe in detail the issue associated with your pool heat pump. If a permanent code appears on the electronic control panel, please advise the Waterco service agent.
9. There are no other warranties, express or implied, including, but not limited to, implied warranties of merchantability or fitness for a particular purpose. During warranty period, Waterco will, at its option, repair or replace, without charge, any product or part, which is found to be defective under normal use and service.

IMPORTANT: The warranty is not transferable and no action can be exercised by a consumer subsequent purchaser of the pool heat pump.

Waterco does not guarantee and will not pay for:

A. Service calls to:

1. Inspect and/or correct the installation of your pool heat pump.
2. Instruct you on how to use your pool heat pump.
3. Replace house fuses or correct power supply problem.
4. Adjust or reestablish water flow to the pool heat pump.

B. When a service call with no manufacturing problem has been detected, on site, by the service company mandated by Waterco.

This Warranty does not cover:

- A. Damage, issues or unsatisfactory performance caused to the equipment by faulty or incorrect external electrical wiring, incorrect power supply, voltage fluctuations, over voltage transients or electromagnetic interference not originating within the equipment.
- B. Damage, issues resulting from incorrect or poor installation.
- C. Failure to provide adequate ventilation for the unit.
- D. Damage or deterioration to the external surfaces or refrigeration coils caused by normal weathering or corrosive atmospheric conditions.
- E. Damage, issues caused by the use of an accessory, component or equipment not supplied by Waterco.
- F. Any costs or additional labour associated with gaining acceptable service access to equipment installed in restricted or unsafe (e.g. high) locations.
- G. Freight charges (including insurance) or travelling cost for repairs performed outside the area normally serviced by Waterco or authorised repair agent.
- H. Any consumable item (e.g. batteries, filters) supplied with the equipment unless the item is shown to be defective at the time of purchase.
- I. Damage, issues or unsatisfactory performance resulting from operation in an environment where the climatic comfort of humans is not the primary function of the equipment. Damage, issues or unsatisfactory performance resulting from operations at conditions outside the operating conditions specified in the Waterco technical or sales literature applicable to the equipment.
- J. Damage, problems or unsatisfactory performance resulting from misapplication of the equipment.
- K. Equipment installed in a transportable or mobile application (e.g. caravan or boat).
- L. Equipment re-installed at a location other than the original location.

OFFICES - AUSTRALIA

NSW - SYDNEY
(HEAD OFFICE)
Tel : +61 2 9898 8600

VIC/TAS - MELBOURNE
Tel : +61 3 9764 1211

WA - PERTH
Tel : +61 8 9273 1900

QLD - BRISBANE
Tel : +61 7 3299 9900

SA/NT - ADELAIDE
Tel : +61 8 8244 6000

ACT DISTRIBUTOR
Tel : +61 2 6280 6476

OFFICES - OVERSEAS

WATERCO (EUROPE) LIMITED
Sittingbourne, Kent, UK
Tel : +44 (0) 1795 521 733

WATERCO USA
Augusta, USA
Tel : +1 706 793 7291

WATERCO CANADA
Boucherville, Quebec, Canada
Tel : +1 450 748 1421

WATERCO (NZ) LIMITED
Auckland, New Zealand
Tel : +64 9 525 7570

WATERCO (C) LIMITED
Guangzhou, China
Tel : +8620 3222 2180

WATERCO (FAR EAST) SDN BHD
Selangor, Malaysia
Tel : +60 3 6145 6000

PT WATERCO INDONESIA
Jakarta, Indonesia
Tel : +62 21 4585 1481

WATERCO SINGAPORE INTL PTE LTD
MAPEX Building, Singapore
Tel : +65 6344 2378

WATERCO VIETNAM COMPANY LIMITED
Ho Chi Minh City, Vietnam
Tel : +84 28 3622 7780

www.waterco.com.au

This web site address will enable you to select the appropriate country website.

WATERCO

Waterco Limited ABN 62 002 070 733

